

Cone Beam 3D Imaging
NewTom
what's next



Making Your Life Better.

BU Medical Equipment

Sede legale ed amministrativa
Headquarters

CEFLA s.c.

Via Selice Provinciale 23/a ▪ 40026 Imola ▪ Italy
t. +39 045 8202727 ▪ 045 583500
info@newtom.it

**Stabilimento
Plant**

Via Bicocca, 14/c
40026 Imola ▪ Bo (Italy)
tel. +39 0542 653441
fax +39 0542 653601

newtom.it



04/2021 NVGEB181500
According to the standards in force, in extra-EU areas the availability and specifications of some products and/or characteristics may vary. Please contact your local distributor for further information. Pictures are for illustration purpose only.

NewTom VGi evo EXPANDED.VISION

EVOLVED 3D IMAGING



NewTom Med

VGi evo EXPANDED.VISION

FROM NEWTOM'S RESEARCH AND INNOVATION, THE COMPLETE MAXILLOFACIAL/ENT CBCT.

Detailed viewing accuracy, superior scanning technology. Multiple FOVs up to 24 x 19 cm for complete Head&Neck 3D diagnostics and 2D examinations in a single scan. The CineX function offers a dynamic view of moving structures. The dose radiated to the patient can be considerably reduced with the ECO Scan mode.

SUPERIOR VISION AND CLEAR DETAILS.

Extraordinary performance and very high quality 2D and 3D images for perfect diagnoses.

NewTom's research and experience has produced VGi evo, the versatile and efficient device that offers technology, safety, comfort and a broad range of FOVs for acquisitions up to 24 x 19 cm. A wide range of volumetric, panoramic and teleradiographic examinations as well as dynamic X-rays for perfect diagnoses in all situations.

With the exclusive Eco Scan acquisition modes and SafeBeam™ technology, excellent image quality can be ensured with very low radiated doses to safeguard the patient's health. The latest-generation head support unit and the technologically advanced control panel offer a simple and efficient user experience with comfortable patient positioning and guided workflow.



BROAD-RANGING DIAGNOSIS

High resolution images in a single scan of the whole **Head&Neck** area, from the cervical to the maxillofacial region, including ears and complete upper airways.



COMFORT AND PERFORMANCE

Easy and comfortable patient positioning with the patented head support unit for excellent image quality.



ECO DOSE

The result of NewTom's twenty-year long experience, ECO Scan mode allows quality diagnoses with low dose of radiations to safeguard the patient's health.



MAXIMUM VERSATILITY

A unique device for excellent volumetric, panoramic and teleradiographic investigations as well as 2D X-ray sequences.



THE NEW REFERENCE OF CBCT.

Outstanding definition and quality with the revolutionary NewTom image chain.

The technologically advanced elements that form the innovative image chain of VGI evo carry the performance of CBCT devices to a new extraordinary level:

- the ultimate large sensor allows to examine a volume up to 24 x 19 cm with increased signal-noise ratio;
- the generator with rotating anode and 0.3 mm focal spot allows to obtain very high definition images to see details and microstructures that cannot be investigated with standard technological devices;
- reconstruction algorithms and image processing, the result of NewTom's twenty years of experience, allow to rapidly obtain exceptional 2D and 3D images.



360°

Complete 360° rotation to rapidly acquire superior quality cylindrical volume with advanced kinematic technology (patented).



HiRes

The degree of accuracy of NewTom Cone Beam CT technology is crucial in case of investigations for endodontics, periodontics and otorhinolaryngology, which require high resolution.



CBCT

The generator with rotating anode and small 0.3 mm focal spot, and SafeBeam™ technology that automatically adapts CBCT exposure parameters to suit the anatomical region investigated provide very high quality images.

EFFECTIVE PATIENT SUPPORT

The patented head support unit offers 7 stability (contact) points and laser guides for the utmost precision in the positioning of the patient. User-friendly and efficient, it is entirely free of metal to avoid artifacts. Its motor-driven chin rest allows to align the position of the field of view to the anatomical area of interest via a servo-assisted movement, also from the image acquisition workstation.

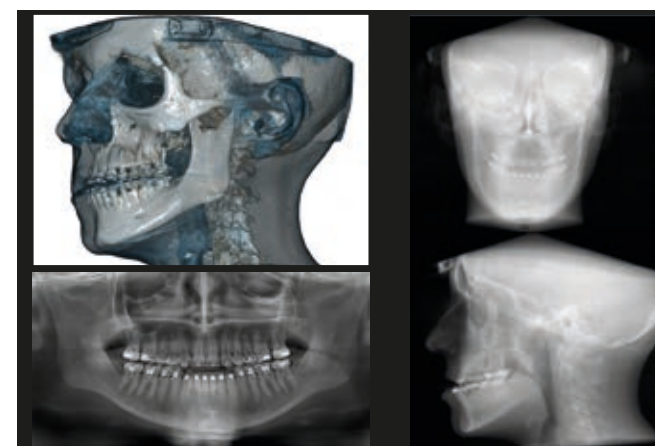

MULTIVISION (4 IN 1)

A single CBCT scan with the Sharp 2D (patented) function can automatically generate a series of 2D projections that include panoramic images and a sequence of teleroadiographic images (AP, PA and LL).

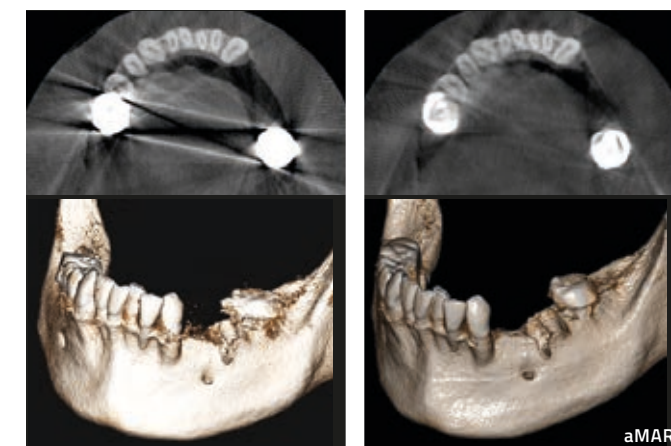

aMAR (autoAdaptive Metal Artifact Reduction)

The aMAR algorithm generates an additional set of images that clearly shows the anatomical structures even when there are multiple metal objects, such as amalgam or implants, that would impair image quality.

EXTENDED 3D DIAGNOSTICS.

Complete FOV range
for perfect
3D volumes
in all situations.

VGI evo is a versatile and effective device with several examination modes dedicated to an extensive selection of clinical applications. The choice of field of view determines the expanse of the anatomical district analysed. VGI evo complies with international standards based on the "ALARA" (As Low As Reasonably Achievable) principle, whose purpose is to reduce the dose absorbed by the patient by selecting the most suitable FOV for the anatomical region of interest.

The exclusive Boosted and Enhanced modes allow to reach, when clinically required, excellent standards of image details and quality for exceptional uncompromising results.



HiRes

Choice of the best type of examination for specific diagnostic needs. The HiRes mode, which can be used for FOVs up to 15 x 5 cm, is ideal for localised anatomical regions with an amazing standard of detail and definition.

ECO

The ECO Scan mode, which can be used with all FOVs, allows to reduce the radiated dose by 50% to safeguard both patient and operator's health.

WIDE-RANGING FOVs

The most wide-ranging FOVs allow, with a single scan, to see complete images of the maxillofacial area for orthodontic applications, orthognathic and maxillofacial surgery.

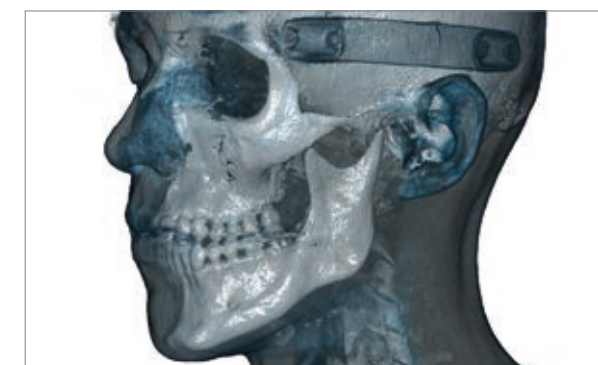
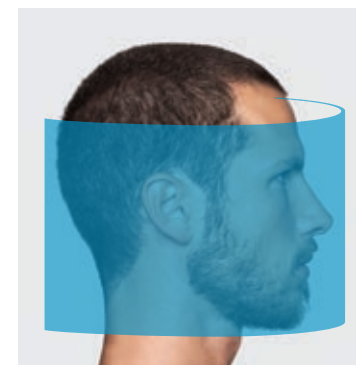

24 x 19

MEDIUM-SIZE FOVs

Medium-size FOVs are indicated for ENT (otorhinolaryngology) and TMJ (Temporomandibular Joint) applications or full dentition examination and implant planning.

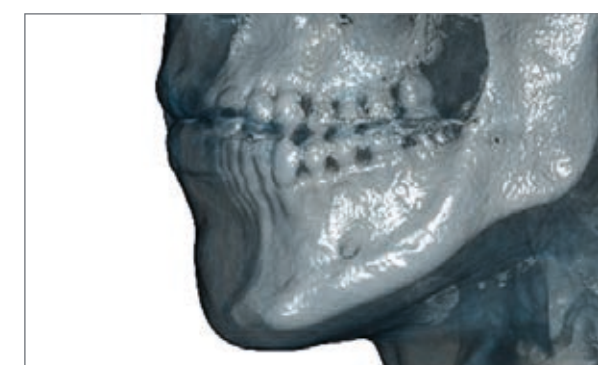
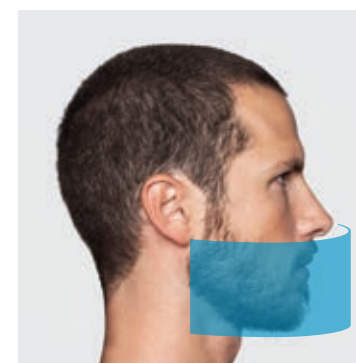

12 x 8

SMALL FOVs

Use of small FOVs is indicated for ENT, endodontic, periodontic and implantology examinations on specific user-selected regions.

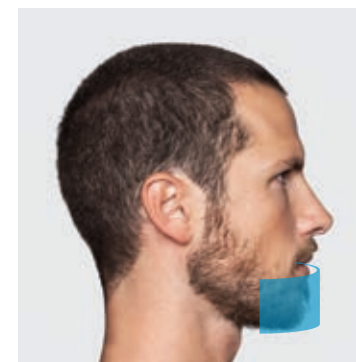

5 x 5



CLINICAL APPLICATIONS.

VGi evo is a powerful and versatile device that expands the clinical use of CBCT.

Its wide range of examinations meets all needs of maxillofacial, otorhinolaryngology, dentistry and orthopaedic-cervical procedures.

The NNT software provides dedicated interfaces and tools to make the most of every specialist physician's work.

MAXILLO

FOVs up to 24 x 19 cm for a complete view of the entire maxillofacial area.

ENT

Very high definition examinations of the internal ear and complete airways.

DENTAL

Complete high quality dental applications for implantology, orthodontic treatment and endodontics.

CERVICAL REGION

Detailed analysis for morphological and functional assessments (CineX).

DENTAL CLINICAL APPLICATIONS.

ORAL AND MAXILLOFACIAL SURGERY

Highly precise details for oral and maxillofacial surgery applications, such as the presence of teeth or fractures, bone density and height, form and inclination of the root. The presence of metal elements does not impact image quality; instead, the small quantity of radiation reduces the scattering effect to a minimum and, therefore, anatomical structures are clearly displayed.

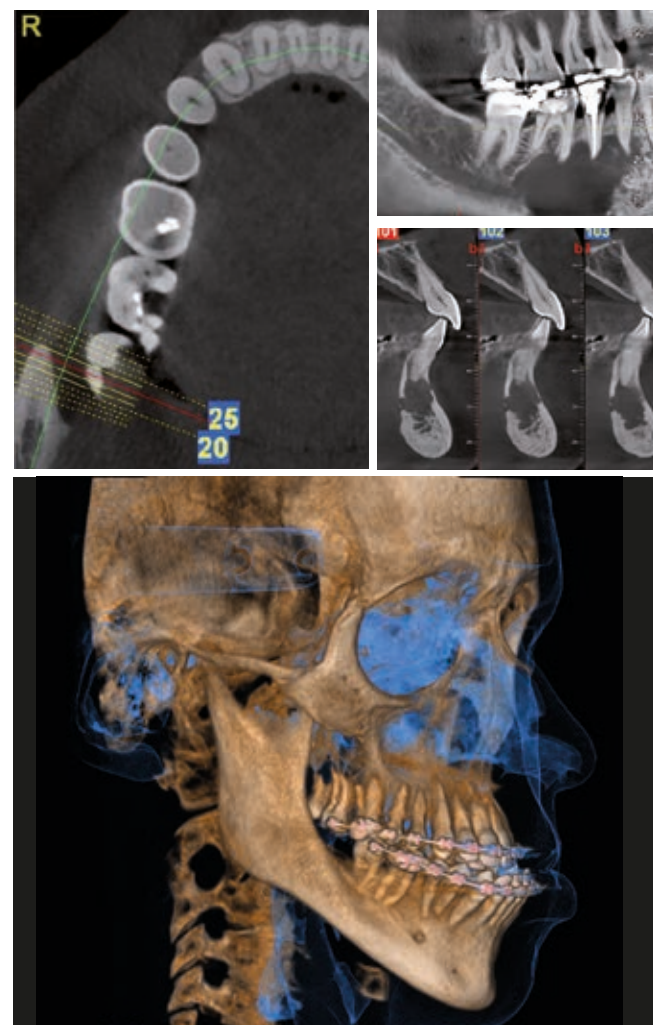

ORTHODONTICS

Cone Beam technology is ideally applied in orthodontic applications for aesthetic purposes and for the treatment of severe diseases. In fact, 3D images provide a very clear and detailed view of the investigated area, generating panoramic, teleradiographic and 3D images in which the area displayed can be modified and the thickness of reconstructed images can be adjusted.

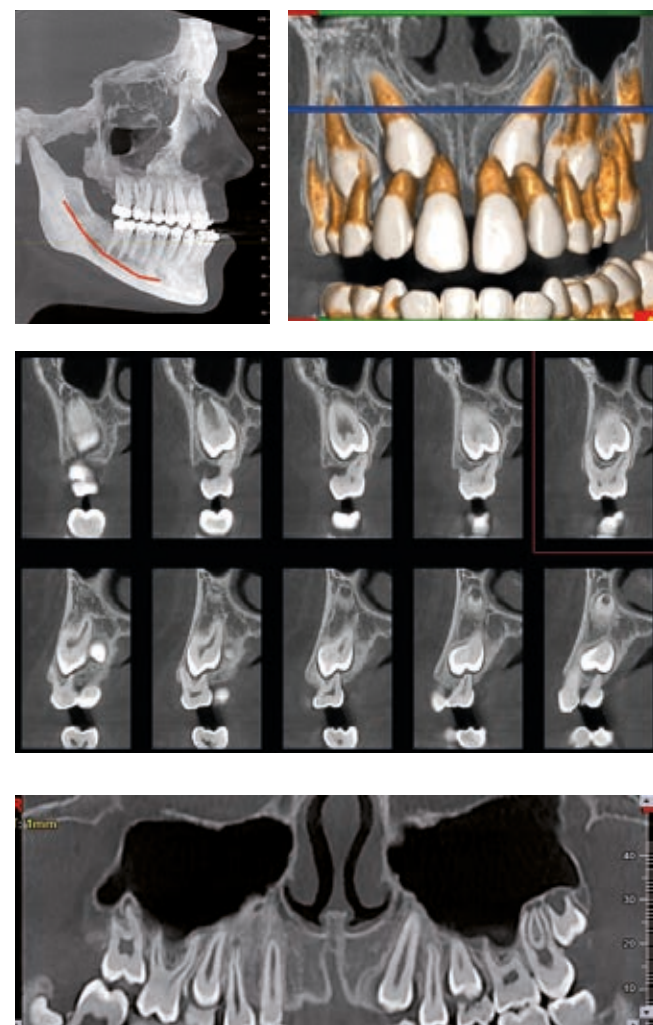

IMPLANTOLOGY

Images produced by a 3D volume reveal diseases and structural anomalies, if any, with extreme detail. Cone Beam technology can generate detailed scans to effectively assess implant sites by obtaining in-depth information about the position, width, osseointegration process rate and any risk of rejection via a direct assessment of bone density at the site (Misch classification).

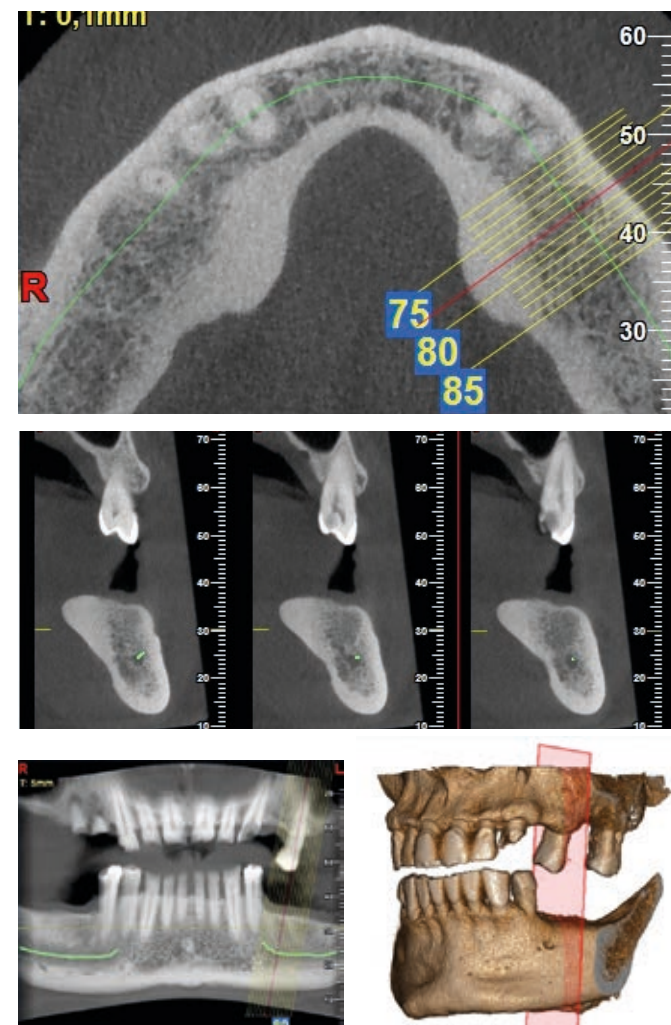

ENDODONTICS-PERIODONTICS

Clear and precise images with VGi evo for endodontic and periodontic applications, such as fractures, mandibular canal therapies and treatment of tissue adjacent to the tooth. These images help to identify every detail of the analysed area, determine the exact disease and correctly plan the most effective treatment.

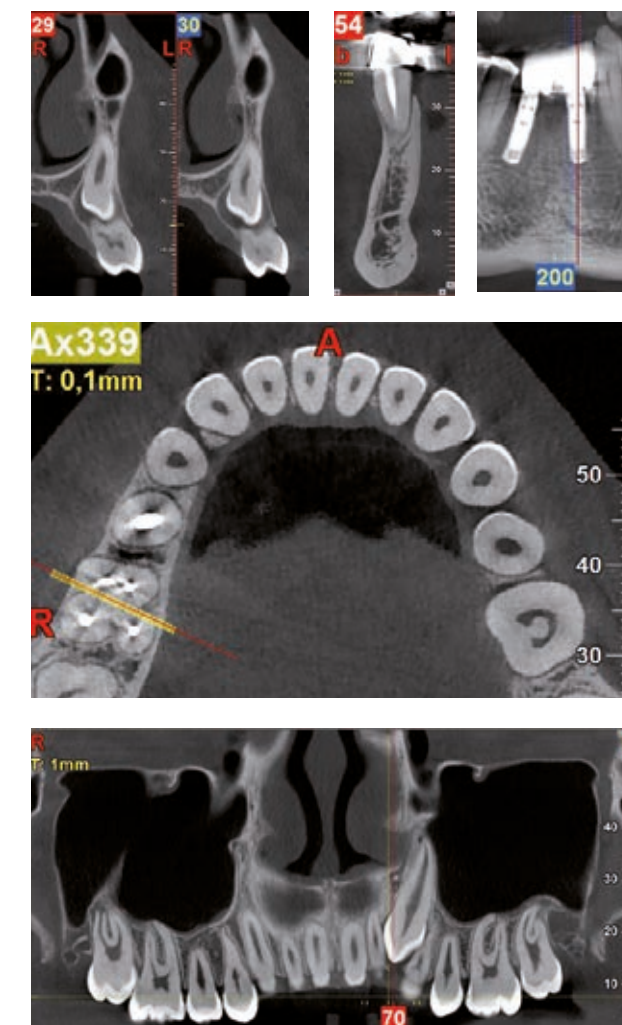

SPECIALIST ANALYSES.

TMJ

High-quality 3D images in the anatomical representation of both the TMJ and the cervical region. Sagittal and coronal slices provide optimal imaging of the joint zone and are essential to identify any pathologies. Panoramic images provide important orthodontic information for initial screening, such as the difference between the height of the condyle and that of the mandibular ramus, or information on other dental pathologies.

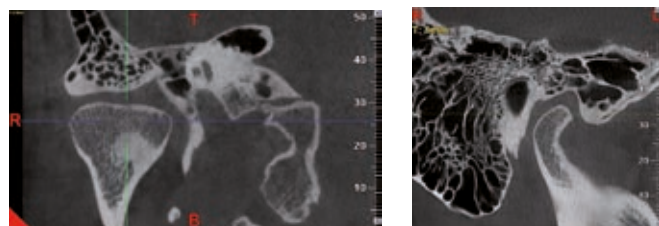
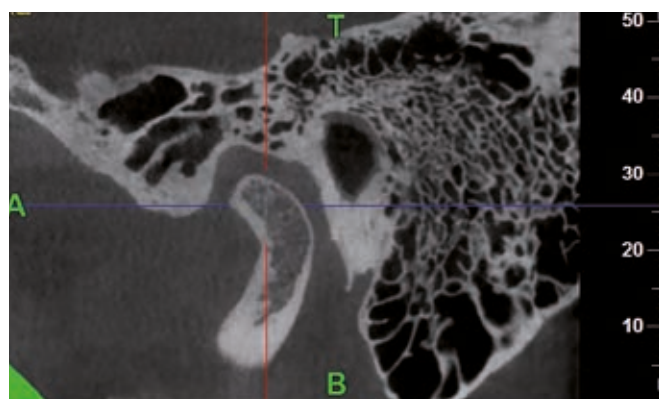
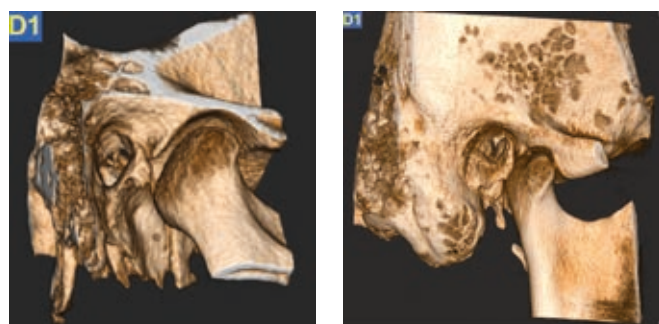

EAR

With a single scan, VGi evo generates HiRes images of airways, both temporomandibular joints, maxillary and nasal sinuses. The clear and precise scans reveal a larger number of details of both the internal ear and the petrous bone. The ideal choice for otorhinolaryngology investigations.

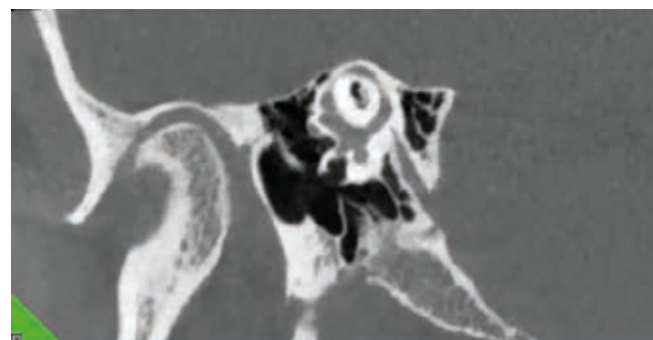
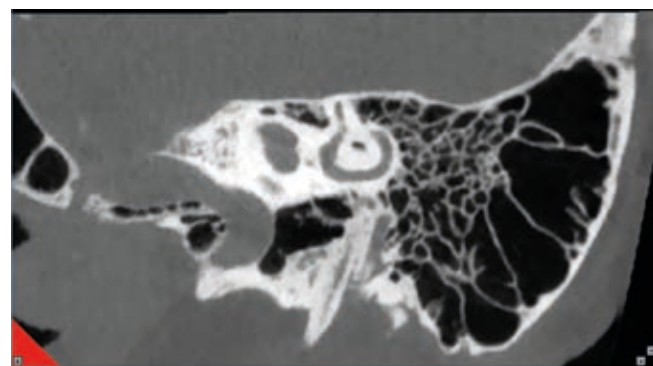
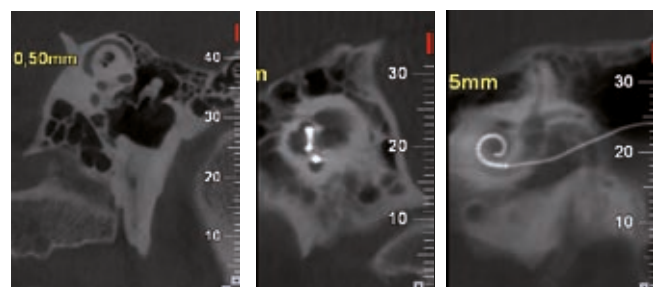

UPPER AIRWAYS

Extra clear images, volume measurements and colour renderings that highlight the most critically narrow areas enable the assessment of airway disorders and diagnoses of sleep apnea (OSA) problems.

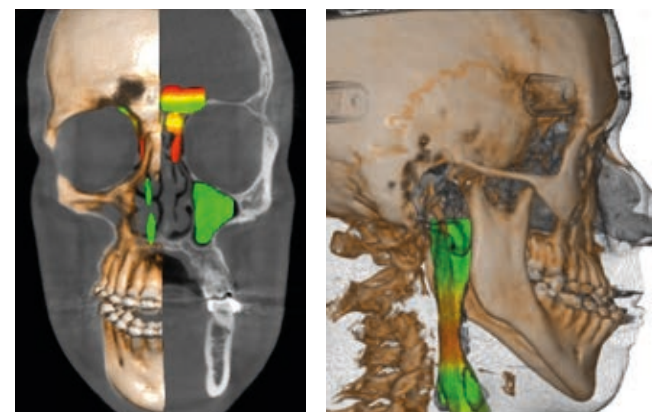
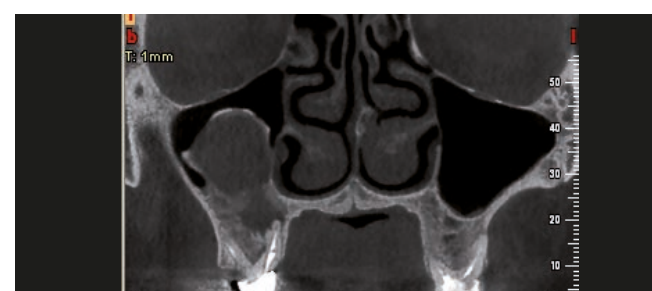
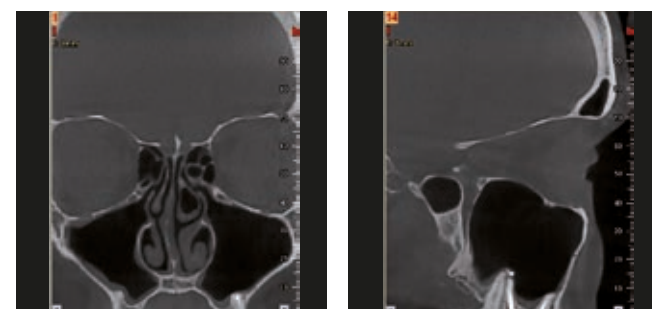

CERVICAL REGION

VGi evo allows detailed analyses of trabecular and cortical structures to identify any dysplastic, inflammatory, traumatic or micro-traumatic elements. Relationships between vertebral bodies are also perfectly legible, thus highlighting any distortion or subluxation. 3D volumes generated with VGi evo are ideal to examine the atlanto-occipital joint. Moreover, the dynamic CineX examination allows to study the moving site to ascertain the presence of any joint disorders.

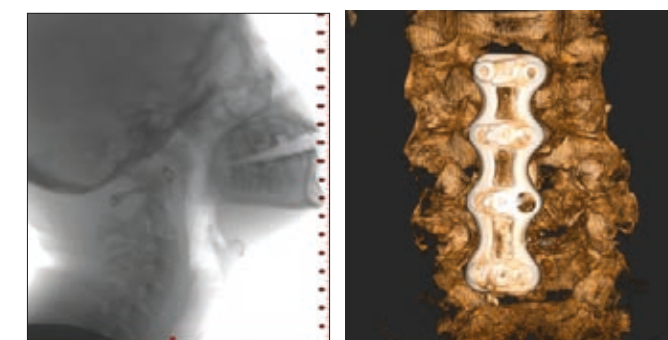
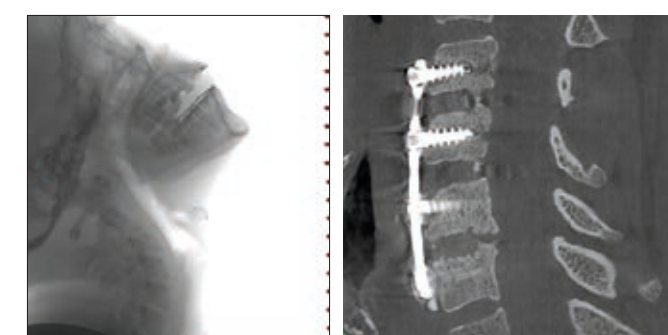

VERSATILE 2D IMAGING.

Panoramic and cephalometric examinations for a precise and complete view.

The innovative VGi evo technology includes a low dose CBCT scan that has been specially developed for combined use with the patented Sharp 2D function, which generates a complete set of 2D images for diagnostic screening and post-surgery follow-up examinations.

Furthermore, the CineX mode offers the specialist physician a dynamic view of moving joints and internal structures.



Sharp 2D – TELERADIOGRAPHIC AND PANORAMIC SCANS

Exclusive function to create a dataset of images from Panoramic and Teleradiographic (AP, PA and LL) scans in a single examination. Compared to the panoramic scan-like coronal reconstructions (panorex) conventionally obtained with CBCT, images produced with Sharp 2D maintain the same magnification and orthogonality ratios; hence, the same clinical evaluation principles of conventional panoramic views apply. Latero-Lateral and Antero-Posterior teleradiographic scans can be used to perform cephalometric examinations and orthodontic rehabilitation.

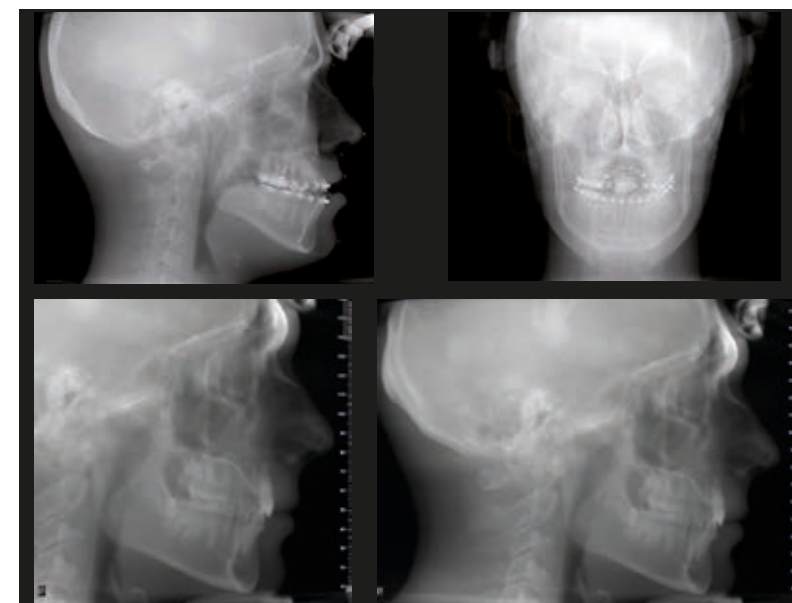

CEPH MULTIPLE

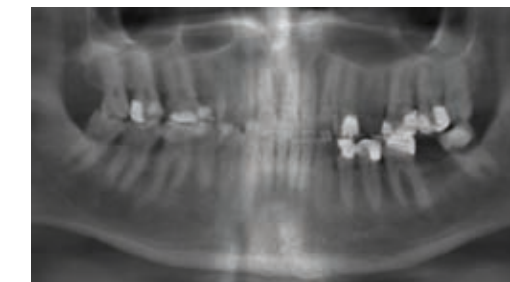

DENT

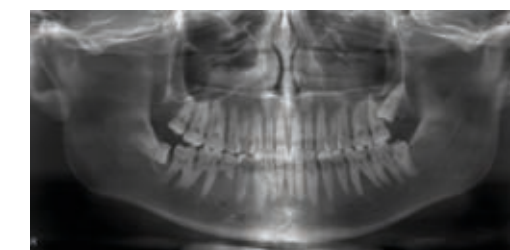

PAN

CineX – DYNAMIC IMAGES

The innovative CineX function, which is provided with a 17 x 19 cm filming area, allows to investigate moving internal anatomical structures (e.g., swallowing, saliva ducts, TMJ disc, cervical vertebrae) by acquiring a sequence of X-rays in video format with AP, PA or LL projections. The videos obtained can then be directly consulted with the NNT software, with the NNT Viewer or exported and viewed with third party applications.



TMJ EXAMINATION

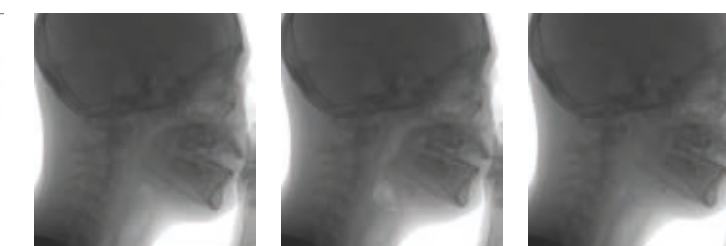

SWALLOWING ASSESSMENT

EXCEPTIONAL OPERATOR AND PATIENT COMFORT.

Functional features and design that facilitate relations and diagnosis.

VGi evo offers excellent ergonomics and stability during scans. The patented head support unit offers 7 contact points for rapid access and natural positioning of the patient.

Three laser lines precisely indicate the references of the area of interest. The mirror placed opposite the chin rest, and acquisition of two low dose scout (latero-lateral and antero-posterior) images provide a complete view of the patient, and allow to check correct position and perfect alignment.

VGi evo provides exclusive tools and technological solutions required to expose the patient only to the necessary dose by adapting to the clinical needs and anatomical characteristics of the area investigated.



USER-FRIENDLY CONTROL PANEL

The new control panel, with wide info display makes machine handling and patient positioning easier, allowing the operator to move the gantry and adjust its height to facilitate patient access to the scanning area. The patented head support unit can be adjusted in three directions and features positioning lasers, which can be activated with the dedicated button on the control panel.

EFFECTIVE COMMUNICATION

Precise diagnosis and complete planning of treatment ensure effective communications between specialist physician and patient, an essential requisite to learn about the treatment in a safe and trust-based setting.



ECO Scan

Pulsed emission technology activates the X-ray source only when necessary, thus limiting patient exposure to a minimum of 0.9 s with volume acquisition 5 x 5 cm and an effective minimum dose of 3.5 μ Sv.



aFOV

With the many dimensions that can be selected and the various scan modes available, examinations can be adapted to the specific requirements of a wide range of clinical applications.



SafeBeam™

SafeBeam™ technology automatically adapts emission according to the patient's anatomical characteristics, thus eliminating any risk of exposure to an unnecessarily high dose.



SOFTWARE NEWTOM.

NNT. TECHNOLOGICAL HEART.

Technologically advanced software for 2D and 3D imaging.

With just a few simple steps NNT can process data acquired during the scan to create a vast array of images, which provide detailed information about patient anatomy.

They can subsequently be saved in a report or distributed with the Viewer version of the software. NNT also provides different application modes specifically intended for implantology, endodontics, periodontics, maxillofacial surgery and radiology.

NNT SOFTWARE COMPATIBILITY

NNT is DICOM 3.0 certified and can interface with third party systems and software to store and exchange medical data.



DENTISTRY: CROSS SECTIONS IN DENTAL PANORAMIC IMAGING

Complete view of the dental arches in cross sections to check shape, size and status of maxillary and mandibular bones and teeth.

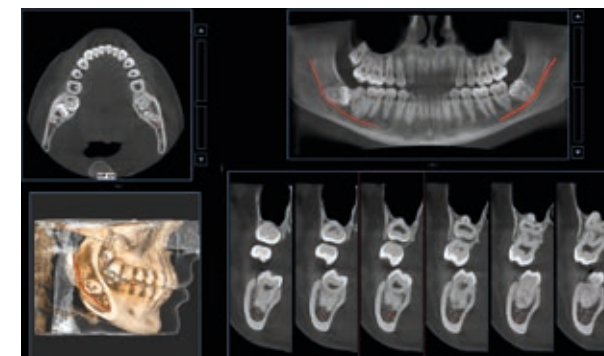

OTORHINOLARYNGOLOGY: FREE MULTIPLANAR SECTIONS

Dynamic high resolution examination of the internal ear along non-orthogonal planes is essential to diagnose any diseases of the ossicular chain, stapes' base, semicircular canals, cochlea and adjacent structures.

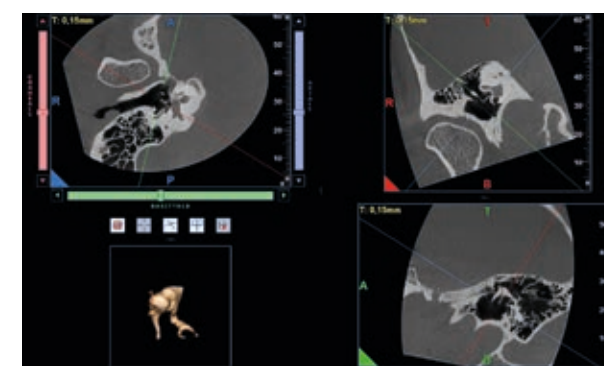

GNATHOLOGY: DUAL TMJ VISION

Simultaneous view of both temporomandibular joints for symmetrical analysis and detection of problems or dysfunction deriving from joint diseases.

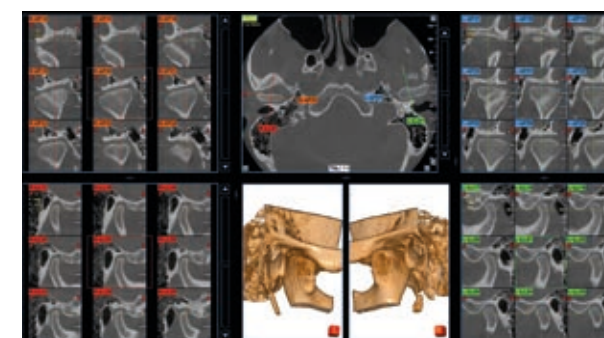

RADIOLOGY: MULTI-SLICE EXAMINATION

Creation of multiple image samples in Med-Like style with personalised orientation for the various assessments of anatomical areas, whose images have been acquired.

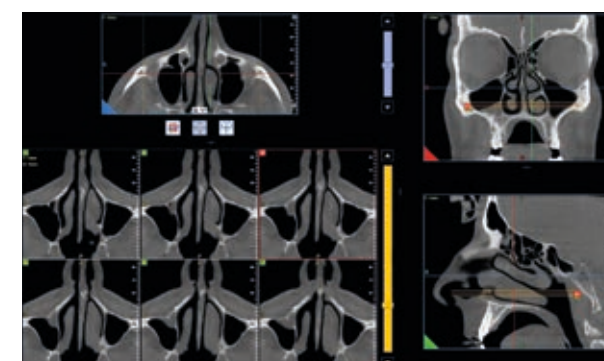

SPECIALIST TOOLS.

Dedicated tools to underpin diagnoses and treatment plan.

The software for NNT implant planning has advanced tools to measure the anatomic district (distances and angles) and trace the inferior alveolar nerve, making treatment planning safer and more precise.

CBCT scans can be processed and analysed to estimate bone density in potential implant sites.

SMART SERVICES FOR 2D AND 3D ORTHODONTICS

Through the CephX cloud server, NNT has access to online artificial intelligence services. This futuristic tool allows automatic cephalometric tracing, to be managed with instant reporting. It is also possible to carry out volume segment by body areas, making each case study even more straightforward, practical and obvious. Finally, airway examination can also be performed with maximised efficiency and accuracy.

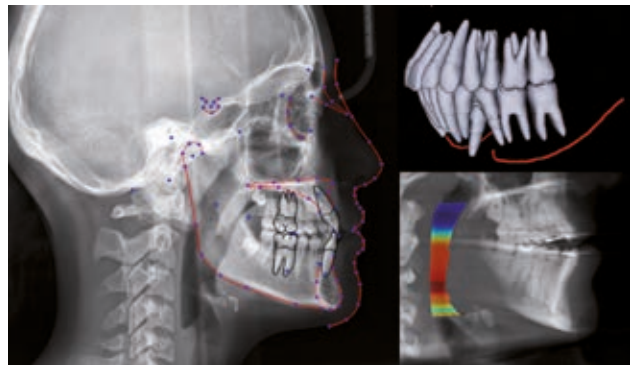

INTEGRATED SOLUTION FOR THE SMILE PROJECT

As part of the aesthetic smile rehabilitation project, the Smile LynX software integrated in NNT simulates the treatment outcome on a photograph of the patient, facilitating communication with both the patient and the dental laboratory, which can then use this information to create a more effective CAD project, directly integrated with 3D Lynx.

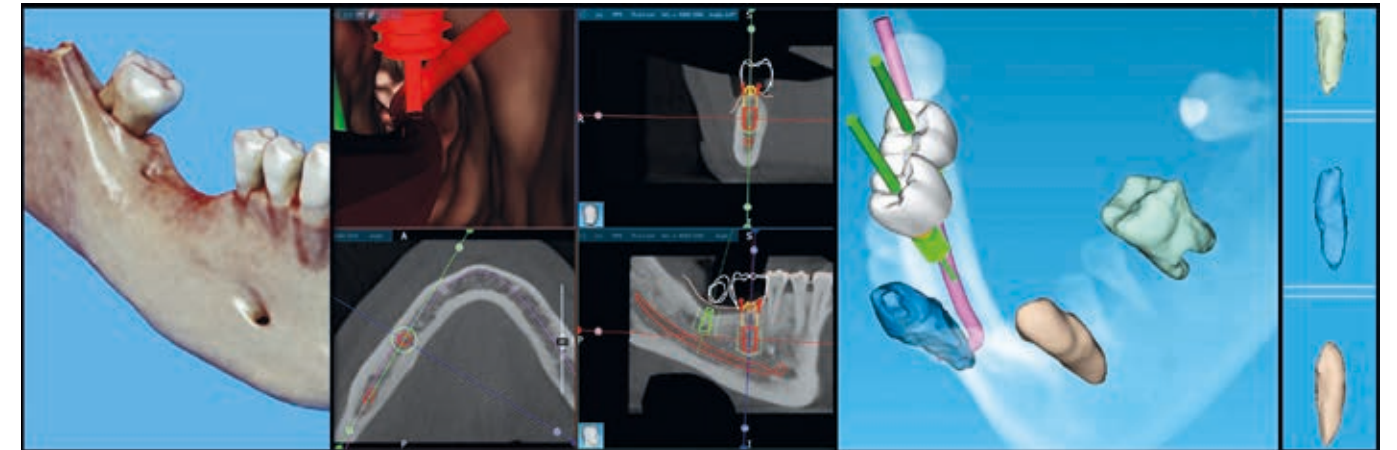

PROSTHETICALLY GUIDED IMPLANT DESIGNING

The module allows implant surgery to be planned with extreme precision. The implant can be positioned by assessing both clinical aspects (bone quality, canal position, etc.) and prosthetic details by combining 3D reconstruction of radiological data with the optical scan of an anatomical model and the related prosthetic project (importable in STL format). The possibility of creating a surgical template for use during the clinical procedure allows implants to be positioned with extreme precision and predictability. Virtual endoscopy navigation ensures an even more intuitive dynamic analysis of the clinical data.

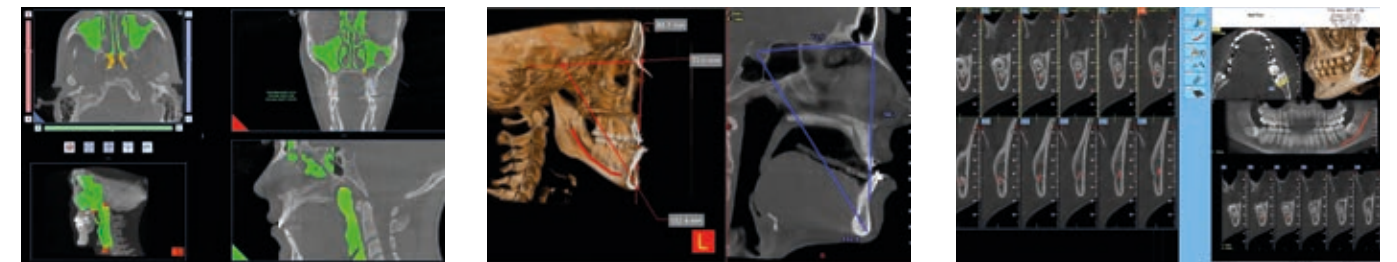

AIRWAY VOLUME ANALYSIS

Estimating the actual upper airway space is essential to diagnose respiratory diseases and sleep apnea (OSA).

2D AND 3D EVALUATION

The possibility to evaluate distances on 2D sections or with 3D rendering to verify any joint problems.

ADVANCED REPORTS

Advanced draft of medical reports to share on PACS, also available in automatic compiling mode.

AN INTERCONNECTED SYSTEM.

An extensive communication environment, from multidisciplinary treatments to technical assistance.

VGI evo benefits from the sharing tools provided by NewTom to improve operations within the dental practice. In particular, the sharing of images and data via cloud optimises the implant rehabilitation process, by ensuring communication between the dentist, implantologist and dental technician. In addition, the Easy Check and Di.V.A. services simplify the monitoring and maintenance of the machines. A proper ecosystem, in which each component interacts with the others to maximise performance.

ALWAYS EFFICIENT

VGI evo, like all the other NewTom extra-oral imaging instruments, can be monitored automatically through the Di.V.A. digital virtual assistant, which provides data and usage statistics to help plan workloads and maintenance. Moreover, VGI evo has access to a remote technical assistance service through the Easy Check software, which provides information on any critical issues and streamlines their resolution in real time.



NNT VIEWER (DEVICE&APP)

Intuitive and efficient, NNT has all the tools to manage and share diagnostic images, facilitating communication with the patient and with the other dental professionals involved. The viewer supplied with the system can be used to browse through the iPad-based 2D image gallery, and all scans can be transferred in DICOM format. The NNT Viewer can be given free of charge to colleagues and patients to allow them to also view images. In addition, NNT is compatible with the MAC platform through Parallels Desktop.



WORKFLOW ON CLOUD-BASED MULTI-PLATFORM

NNT provides the implantologist with a cloud-based platform where to store libraries of implants and abutments. The implantologist can thus plan surgical procedures and share data with the dentist and dental technician, by also being able to access a secure chat system. The platform ensures a certified, optimised workflow designed for specialist clinical use, aimed at creating surgical templates by using 3DIEMME* services or producing them in-house via the RealGUIDE DESIGN* software version and 3D printer. Among the many features available, there are importing and overlay of STL files, PLY of digital impressions and/or prosthetic designs obtained via an optical scanner; simplified segmentation of the volumetric data of anatomical parts, exportable to STL; and project exporting to open CAD/CAM software for provisional implant management.



* This is an independent software product. Verify with the local distributor whether this function is legally approved and available in your country.

COMPLETE CONNECTIVITY.

Excellent connectivity and integration with the modern systems adopted by NewTom. Workflow and clinical and diagnostic activities become much easier and highly performing.

REMOTE ASSISTANCE AND I.O.T.

By connecting the device to the Internet, it is possible to carry out remote technical assistance and to monitor operation with Di.V.A. and Easy Check from an I.o.T. perspective. The device will send information on its own performance and any critical issues.

3D/2D VIEWER

Examinations can be shared with colleagues and patients by providing the Viewer directly on CD, DVD or a USB storage device.

1:1 PRINT

Complete and flexible report for storing and sharing colour reports on photographic paper or grey scale reports on X-ray-equivalent transparencies.

OTHER ACQUISITION DEVICES

Compatibility with TWAIN standard and DICOM 3.0, guarantees the NNT software management of images from other 2D/3D image acquisition devices, such as video cameras, sensors, PSP and CBCT scanners.

MULTI-STATION DISPLAY AND PROCESSING

Image storage on a shared database in a local network that can be accessed from any workstation and iPad (only 2D). Management of multiple archives and access to password-protected data.

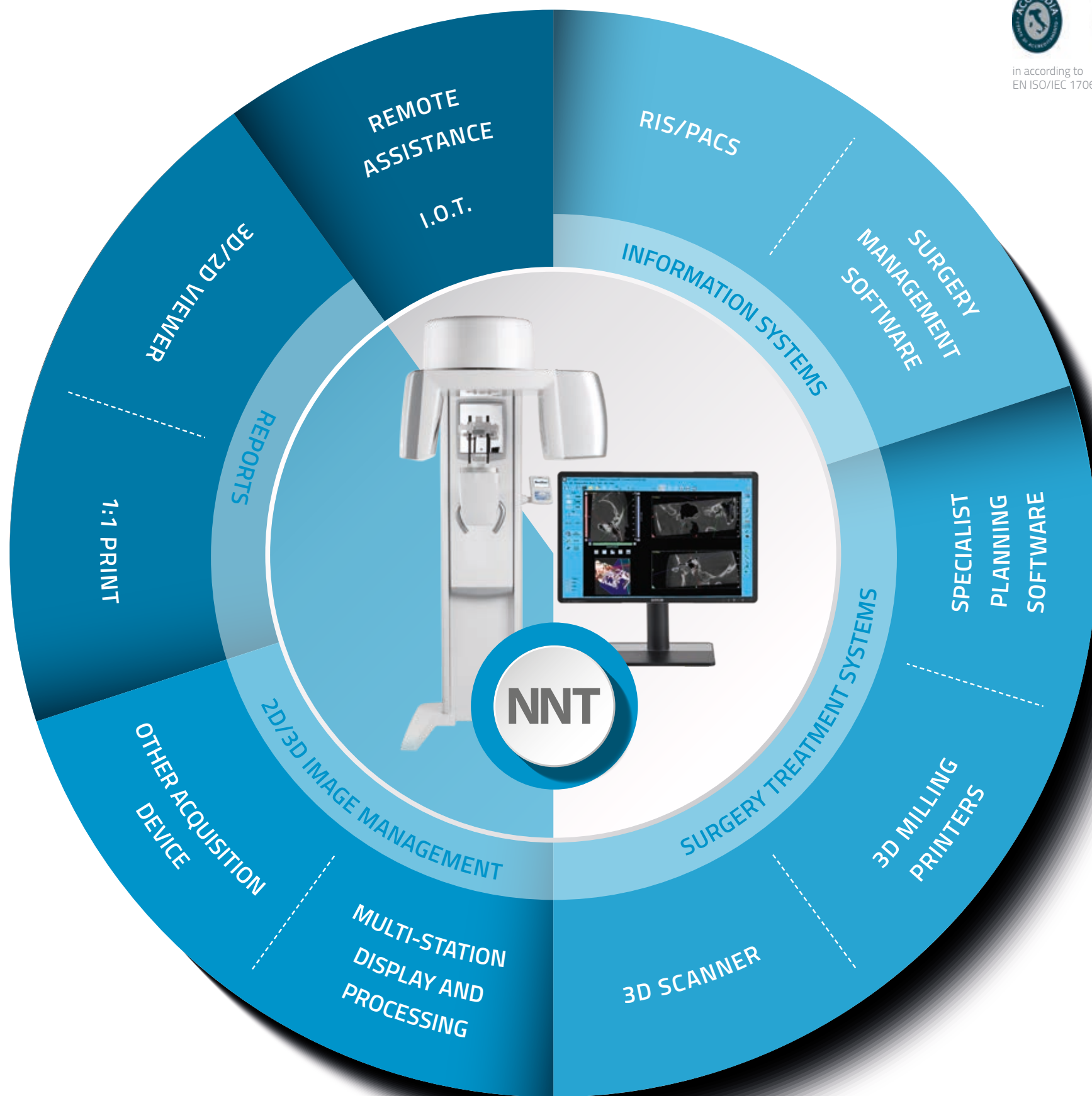

in according to
EN ISO/IEC 17065:2012

NNT: CERTIFIED SOFTWARE

NNT has been granted the ISDP® 10003 international scheme for data protection certification, to assess compliance with the European Regulation 2016/679 concerning the protection of individuals with regard to the processing of personal data.

Di.V.A. AND EASY CHECK

To ensure maximised workflow smoothness, the Di.V.A. digital virtual assistant provides data and usage statistics to plan workloads and maintenance. The Easy Check tool also ensures continuous remote technical monitoring, to facilitate maintenance scheduling and anticipate the resolution of any critical issues.

RIS/PACS

IHE compliant system that allows communication with RIS/PACS systems and DICOM printers. Complete services available: Print, Worklist, Storage Commitment, MPPS and Query/Retrieve.

SURGERY MANAGEMENT SOFTWARE

An open system designed for fast, efficient interfacing with the main dental surgery management software solutions via various standard VDDS, TWAIN and/or proprietary NNTBridge modes.

SPECIALIST PLANNING SOFTWARE

Exports in DICOM 3.0 format to specialist planning software to process orthodontic treatments, prostheses, implants, orthognatic and maxillofacial surgery.

3D MILLING PRINTERS

Software modules are available to segment the reconstructed volume and export to STL format the surfaces required to create 3D models that can underpin planning and treatment.

3D SCANNER

Prosthetically guided planning by integrating (via the dedicated software module) data in STL format from optical, intraoral or laboratory scanners, with volumetric data.

TECHNICAL SPECIFICATIONS.

X-ray source	High frequency generator, rotating-anode X-ray tube; 75-110 kV, 1-32 mA (pulsed mode)					
Focal spot	0.3 mm					
Exposure Control	SafeBeam™ to reduce exposure according to patient build					
Sensor	Amorphous silicon flat panel					
Grey scale	16-bit					
3D scan time	15 - 25s					
3D emission time	0.9s - 6s					
3D image acquisition	Single scan with Cone Beam technology. 360° rotation					
Available FOV Diameter x Height	Resolution		Selectable 3D scan modes			
	Standard	HiRes	Eco	Regular	Boosted	Enhanced
24 x 19 cm	■		■	■	■	■
17 x 19 cm	■		■	■	■	■
16 x 16 cm	■		■	■	■	■
15 x 12 cm	■		■	■	■	■
15 x 5 cm	■	■	■	■	■	■
12 x 8 cm	■	■	■	■	■	■
10 x 10 cm	■	■	■	■	■	■
10 x 5 cm	■	■	■	■	■	■
8 x 8 cm	■	■	■	■	■	■
8 x 5 cm	■	■	■	■	■	■
5 x 5 cm	■	■	■	■	■	■
Selectable voxel size Standard	200 - 300 µm					
Selectable voxel size HiRes	100 - 150 µm					
Reconstruction time	Less than 1 minute					
Image acquisition Sharp 2D	Panoramic and LL, AP and PA telerradiographic images from a single scan. Exposure 2.4s 75 kV					
CineX image acquisition	1-36s Serial Radiography, field of view 17x19 cm (HxW)					
Patient positioning	Standing, sitting or in wheelchair					
Weight	Scan unit 377 kg, control box 95 kg					
Software	NewTom NNT (ISDP®10003:2020 compliant in accordance with EN ISO/IEC 17065:2012 certificate number 2019003109-2) with Viewer software, free					
DICOM nodes	IHE compliant (Print; Storage Commitment; WorkList MPPS; Query/Retrieve)					
Power supply	15A @ 100/115V~, 12.5A @ 200V~, 10A @ 220/230/240V~, 50/60Hz					

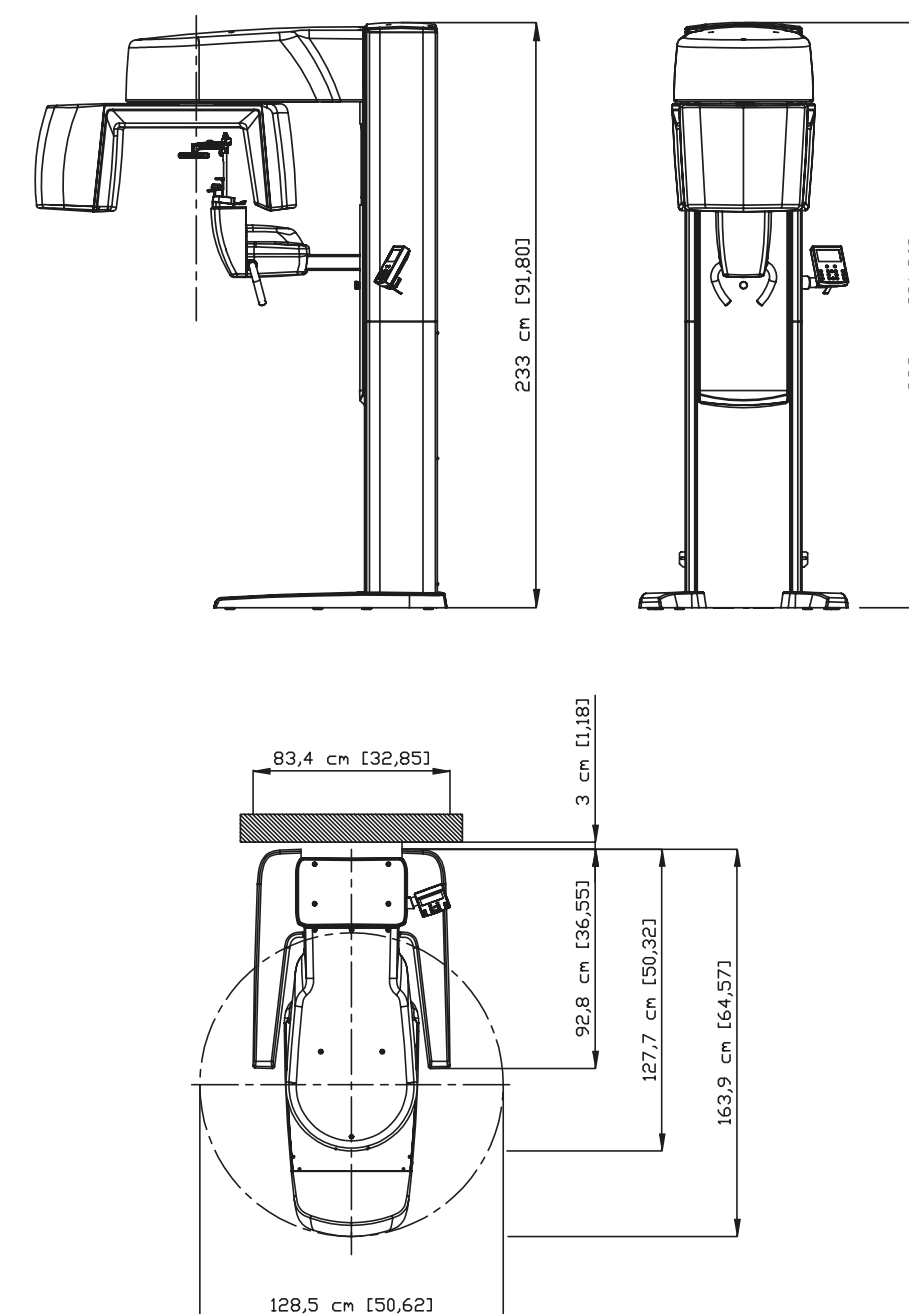

Dimensions in centimetres
(dimensions in inches)

Specifications subject to change without prior notice.

