

# PUMA ELI R

UNMISTAKEABLE DESIGN  
AND AUTHENTIC VERSATILITY



CASTELLINI.COM



CELI08231S01

10/2023

Due to our policy of constant technological upgrading, technical specifications may be subject to change without prior notice.  
According to the standards in force, in extra-EU areas the availability and specifications of some products and/or characteristics may vary. Please contact your local distributor for further information.



**BU Medical Equipment  
Sede Legale Ed Amministrativa  
Headquarters**

CEFLA s.c. - Via Selice Provinciale, 23/a - 40026 Imola (BO) - Italy  
Tel. +39 0542 653111  
Fax +39 0542 653344

**Stabilimento  
Plant**

CEFLA s.c. - Via Bicocca, 14/C - 40026 Imola (BO) - Italy  
Tel. +39 0542 653441  
Fax +39 0542 653601

CASTELLINI.COM

# ESSENTIAL STYLE

The essential nature of Puma ELI R lets dentists perform their everyday work with calm and ease. Extremely manageable, compact and packed with ergonomic features that streamline work, Puma ELI R is also the right solution for those seeking reliability and intrinsic quality.  
**Streamlined essentiality.**



# BALANCED DESIGN

Fluid movements and outstanding ergonomics to meet the needs of dentists who work with hanging tubes. The CP model is compact and features a dentist's module that can be positioned anywhere around the patient to make treatment easier whatever the clinical circumstances.  
**The pleasure of balance.**



# PRACTICAL VERSATILITY



Maximum operating freedom in the surgery demands a flexible solution that lets dentists work comfortably in any situation. With the Cart or Single Cart model, the dentist is free to select the most comfortable position and enjoy the absolute practicality of an independent solution.

**The benefit of versatility.**



Single Cart

# TAILOR-MADE FOR ORTHODONTISTS

Designed for orthodontists, Puma ELI R ORTHO benefits from a design that meets the dentist's specific needs during orthodontic treatment. The optional tray holder can reach the operating area with ease thanks to the mobility and extension of the arms. The assistant's side is ready for 1 or 2 dynamic instruments, controlled via a convenient display. **Set up for orthodontics.**



Module with dynamic instruments.



Large tray holder



# COMPACT DESIGN SUITABLE FOR ANY SURGERY

Extremely compact, Puma ELI R is also suitable for surgeries requiring equipment that is as small as possible. Perfect also for narrow surgeries, the dental unit has been designed to ensure excellent mobility of the various elements. This means the dentist always works with the instrument module in the position best suited for the treatment in progress.



## DENTIST'S MODULE

Light and manageable, the dentist's module for over the patient delivery instruments can be positioned effortlessly, accompanying the dentist's every move. Pressing the on-handle button (optional) lets the dentist quickly adjust the height of the instruments to work in complete comfort.

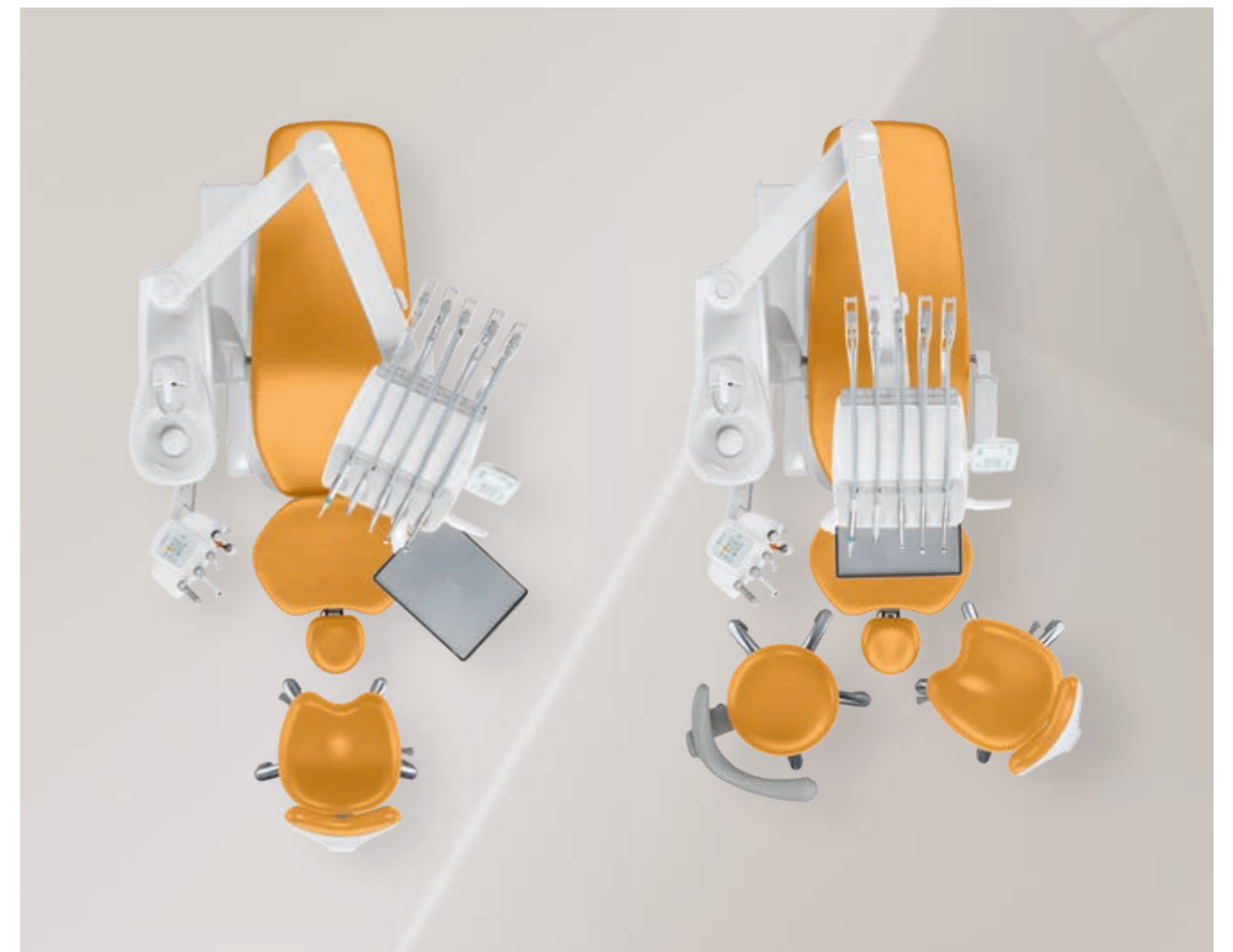

## TRAY HOLDER

The stainless-steel tray holder table can rotate to be placed within easy reach of medical staff. It can be easily removed from the swivel support for sanitisation purposes. A compact tray of minimum size and bulk is available as an alternative.



## BALANCED INSTRUMENTS

The instruments are self-balanced to avoid any traction on the dentist's wrist, while the tubes feature increased extension capacity to minimise unnecessary movements in the operating field. Moreover, instrument lever length is limited to avoid any interference with the operating light. Optional end-of-stroke lever lock system available.



## SIXTH INSTRUMENT

To the side of the module the dentist can add the intraoral camera or curing light.

# SMOOTHER WORKFLOW THROUGH IMPROVED MOBILITY

The CP model with dentist's module for hanging tube instruments can reach any working position with ease thanks to the extremely agile arm system. The dentist can also work in indirect vision mode, with or without an assistant.



## DENTIST'S MODULE

The layout has specifically been designed to facilitate pick-up; for example, instruments are placed in holders with tilt angles that vary from the central holders to the outer ones.

Designed to facilitate instrument re-positioning, the holder always ensures maximum stability. Featuring a wraparound shape and ergonomic design, the handpiece holder smooths the dentist's workflow.

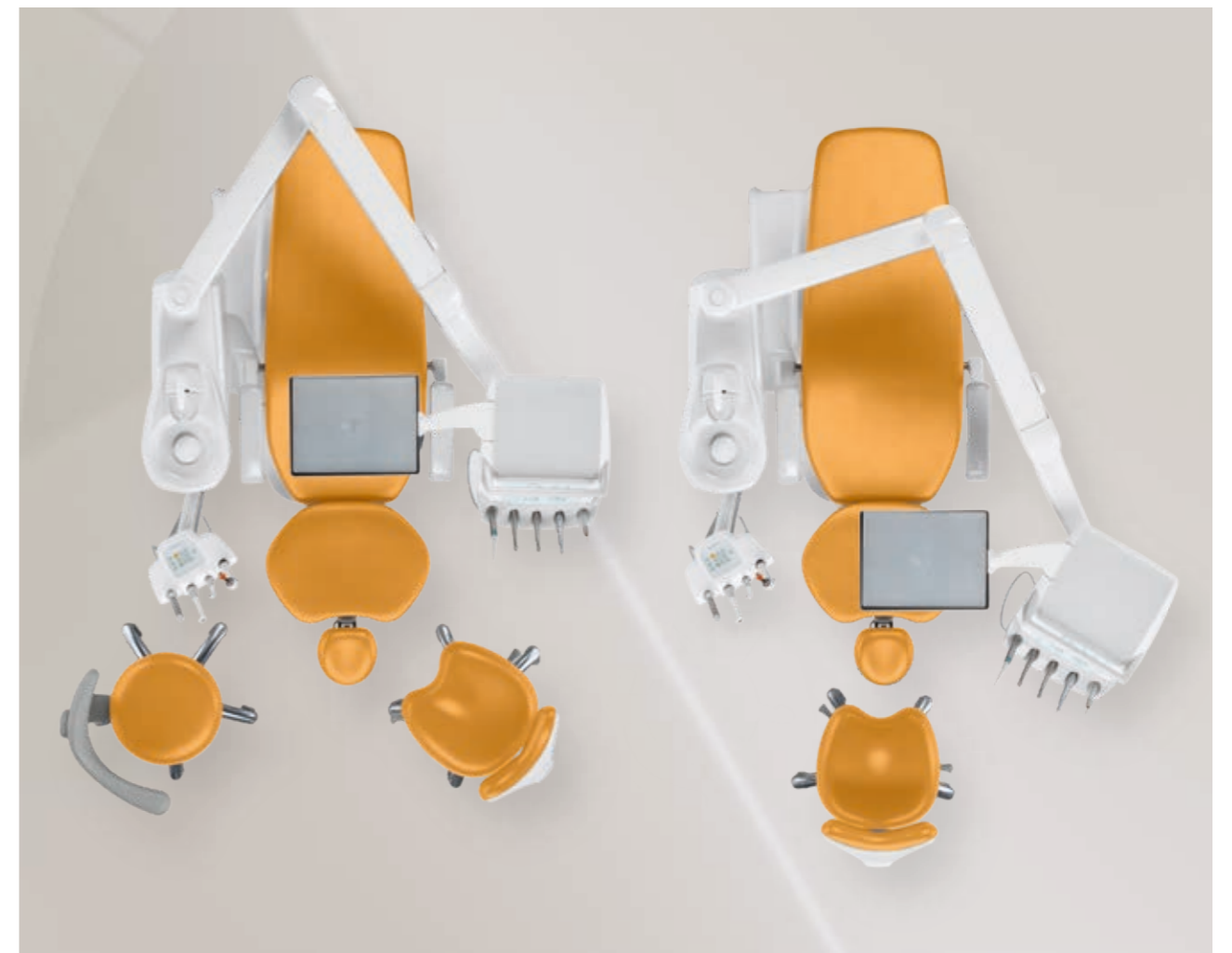

## TRANSTHORACIC TRAY HOLDER

The transthoracic tray holder features a wide supporting surface that does not interfere with the patient. It can be positioned and moved horizontally.



## SIXTH INSTRUMENT

The sixth instrument can be integrated on the side of the module. The dentist can choose between the intraoral camera and the curing light.

# AN ADVANCED, CUSTOMISED ASSISTANT'S SIDE

With Puma ELI R, Castellini makes the most of the assistant's role and provides an array of solutions to suit every preference. The module arm may be of the single or double-articulated type to place it nearer the patient or the dental unit body.



## ASSISTANT'S MODULE

The assistant can manage a wide range of functions via the on-module control panel. This lets dentists focus their attention on actual treatment. In addition to patient chair movement controls, there are also controls for the lighting, cuspidor bowl and Autosteril system.

The assistant's module can be equipped with an optional stainless steel tray holder.



## POSITION-ADJUSTABLE CUSPIDOR BOWL

Cup filling is completely automated via an optical sensor, giving the patient greater autonomy. Made of ceramic, the cuspidor bowl is position-adjustable to provide maximum rinsing comfort.



## ASSISTANT'S MODULE

The assistant's module can be adapted to clinical situations in which treatment is performed by dentists working alone or with an assistant. It is available with 4 or 5 holders. In addition to syringe and suction cannulae, it is also possible to add a camera and a curing light or a dynamic instrument. An optional position-adjustable tray holder is also available.





# INSTRUMENTS UNDER CONTROL

To optimise chair-side workflows it's important to be able to rely not just on perfectly integrated instruments but also on direct control via a user-friendly instrument control panel. Being able to monitor and set operating parameters via the touchscreen also makes treatment flows more efficient.



## TOUCHSCREEN CONTROL PANEL

Puma ELI R is equipped with a new instrument control panel with touchscreen display and integrated X-ray viewer. An alphanumeric display allows for smooth conservative dentistry function management, providing essential data and allowing operating parameters to be set directly. The "clean" button temporarily disables the touchscreen to allow sanitisation.



## HANDY POWER MICROMOTOR

Handy Power is an extremely lightweight, compact brushless micromotor, available with or without LED lighting. Ideal for prosthetic and conservative treatment, especially the FLUO version which incorporates the brand new FIT technology (Fluorescence-aided Identification Technique) that can identify the presence of composite materials with a special UV LED light. Fluorescence-assisted identification speeds up the removal of all composite materials, which are increasingly common and increasingly difficult to identify when applied properly.

- Speed from 100 up to 40,000 rpm with 1:1 ratio
- Maximum torque up to 3.3 Ncm
- Possibility of pre-setting maximum speed



## T-LED

The curing light can be used as a direct version or 120° angled version. With a high-power LED up to a maximum of 2,200mW/cm² and a 430 to 490nm emission band, the T-LED lamp offers 6 pre-set programmes and a sterilisable optical guide.



## PIEZOLIGHT 6 / PIEZOSTERIL 6

Available with and without fibre optic for LED lighting, these versatile and multifunctional ultrasound handpieces are suitable for prophylaxis, endodontics and periodontal procedures.



## SILENT POWER TURBINES AND GOLDSPEED CONTRA-ANGLES

Castellini offers a complete set of turbines and contra-angles suitable for all fields of dentistry.

# COMFORT ABOVE ALL ELSE

Successful treatment depends on ensuring comfort for patient and medical staff alike. If a patient feels at ease, he/she will always be more collaborative. That's why Castellini has perfected working ergonomics by designing a patient chair that ensures operating convenience for the dentist and comfort for the patient. An optional sensor detects patient presence and transmits the statistical data to the Di.V.A. virtual assistant (if present) to monitor effective usage of the dental unit over the period in question.



## THE CENTRE OF WELLBEING

Castellini has designed a system that gives dentists greater freedom of choice with regard to positioning the dental unit inside the practice and hooking up to existing connections.

Depending on the floor outlets and their position, the dental unit can be installed using the connection located directly under the leg rest or the one under the front part of the unit body.

Type-approved to lift up to 190 kg, the patient chair accompanies the patient gently, minimising compression in the lumbar area. With extremely fluid starts and stops, chair movements remain reassuring at all times.

Thanks to the sensor, users can apply settings that leave the dental unit on stand-by once the patient leaves in order to reduce energy consumption. The system also includes automatic switching on/off of the operating light as a function of patient presence.



## PNEUMATIC HEADREST

Available as an optional, the exclusive pneumatic-release orbital headrest pivots on three axes and allows for quick, precise assisted positioning. The button on the lower side of the headrest activates the movement.



## STANDARD HEADREST

The easy-to-adjust headrest can be adapted to patients of different heights.



## MEMORY FOAM UPHOLSTERY

Available as an optional, Memory Foam padding adapts to patients of any build, ensuring proper anatomical support and maximum comfort at all times.



## FOOTREST

Available as an optional, the extension-adjustable footrest allows for easy, thorough disinfection.



## LATERAL SLIDE FOOT CONTROL

Can activate Chip Air and Chip Water on the instrument in use and control patient chair movement. Cabled and wireless versions available.



## PRESSURE-OPERATED FOOT CONTROL

Provides the same functions as the lateral slide foot control. Cabled and wireless versions available.



## POWER PEDAL FOOT CONTROL

The third foot control includes the functions of the previous models and is characterised by two additional elements to recall two more saved working positions. Cabled and wireless versions available.

# THE RIGHT LIGHTING MAKES ALL THE DIFFERENCE

Proper illumination of the operating area is essential. Castellini offers dentists a wide selection of Venus series lamps with a broad performance range. Easily adjustable and ergonomic, these lights let dentists select the lighting level best suited to clinical needs; they also feature removable handles and front panels to make cleaning easier. In addition to the standard Venus E LED lamp, three other models can be fitted as optional equipment items.



## VENUS E LED OPERATING LIGHT

Supplied as standard with 3-axis movement, front panel, removable handles and six LED sources to minimize shadows. Light intensity can also be set, via the sensor, within the 7,000 - 40,000 Lux range.

The No Touch sensor lets the user switch the lamp on/off without touching any button.



## VENUS LED MCT OPERATING LIGHT

Featuring exceptional brightness, this light makes it possible to set specific temperature values according to clinical requirements: warm, neutral and cool light. The No Touch sensor can switch the lamp on/off and adjust light intensity up to 50,000 Lux. The hermetically sealed front screen is easy to clean, and the handles can be removed and sterilised in an autoclave.

In composite mode the light wavelength is modified to prevent pre-curing of the composite materials, simultaneously ensuring optimal lighting of the operating area.



## VENUS PLUS OPERATING LIGHT

High-performing operating light with three-axis rotation for precision adaptation of spotlight to the oral cavity. Adjustable light intensity from 8,000 to 35,000 Lux. Colour temperature 4,900 K, rear fan, removable handles suitable for cold-disinfection.



## VENUS LED OPERATING LIGHT

This LED operating light rotates on three axes, is equipped with the No Touch sensor to switch it on and adjust light intensity and features an easy-to-clean hermetically sealed front screen. Max. 50,000 Lux, colour temperature 5,000 K, autoclavable handles.

# ADVANCED SYSTEMS FOR ENHANCED SAFETY

Castellini has always been attentive to the issue of hygiene, reaffirming its commitment through close cooperation with the Department for Public Health and Infectious Diseases of the Sapienza University of Rome and the Department for Public Health and Paediatrics of the University of Turin. Thanks to in-depth research and analysis, the dental unit can be configured with upgraded and certified devices that ensure the clinical environment is safe at all times.



## AUTOSTERIL

Puma ELI R can be equipped with Autosteril, the high-standard automatic disinfection system for all the spray water circuits.

Used together with Peroxy Ag+, the Autosteril system ensures a mycobactericide, bactericide and anti-Legionella action, certified by the Sapienza University of Rome. Analysis has demonstrated that the disinfection provided is sufficient to "eradicate all tested microbes from the piping of the dental unit, even with higher contamination levels."

Autosteril helps sanitisation at the end of a day's session and allows short cycles to be performed via the following steps:

- circuit draining with compressed air;
- addition of 3% H<sub>2</sub>O<sub>2</sub> to the spray water circuits;
- a liquid 'hold time' suitable for intensive disinfection ;
- liquid expelled with compressed air;
- [mains or distilled] water flushing.

## M.W.B.

Reliable and effective, the M.W.B. system, used in conjunction with Peroxy Ag+, acts against all water-borne contaminants, including Legionella. Tests carried out on a dental unit over a 3-month observation period showed that regular use of M.W.B. and daily execution of an intensive disinfection cycle with the Autosteril system, ensure outstanding water hygiene quality, with bacterial loads kept to zero.



## TIME FLUSHING

To drain stagnant fluid from the piping after use, the Time Flushing feature carries out a complete water exchange with a timed flow of the supply fluid.



## S.S.S. BOTTLE

The stand-alone supply system is equipped with a 1.8 litre capacity pressurised tank, easily accessible from outside to facilitate filling or replacement.

# PREVENTION FIRST AND FOREMOST



## S.H.D.

Flushing and sanitisation of the suction system with water and a special liquid take approximately 2 minutes: ideal as a between-patients cleaning procedure. Option only available where a double filter is present.

Through careful analysis of potential contamination risks in the surgery and around the patient chair, Castellini designs the unit using elements and strategies that ensure constant protection for the patient and medical staff. Surfaces suitable for frequent sanitisation and numerous removable components help keep the workplace healthy and, as far as possible, risk-free.



## CUSPIDOR BOWL

The cup-and-bowl-fill unit can easily be removed and sterilised in an autoclave. Note that the cuspidor bowl handle is removable and autoclavable.



## REMOVABLE, AUTOCLAVABLE HANDLE

Can be easily removed for maximum hygiene.



## REMOVABLE LIGHT HANDLES

Venus E operating light handles can be removed easily for thorough cleaning.



## SUCTION TUBING

The supplied tubing is light and flexible. Alternatively, easy-to-sanitise smooth twin-chamber suction tubing is available.



## DOUBLE FILTER

Optional feature allowing independent cannulae selection; the filters can easily be removed to facilitate draining and cleaning operations.



## SINGLE FILTER

Easily removable to make emptying and cleaning tasks simple.

# INSTANT DIAGNOSIS

Obtaining a quick diagnosis is easier when the image-based communication system is integrated on the patient chair. This lets dentists capture, illustrate and share information with the patient immediately. The multimedia system (optional) consists of a camera with HD sensor, an X-ray sensor integrated on the module and a 22" LED monitor with a 16:9 aspect ratio.



## INTEGRATED VIDEO CAMERA

The camera features a streamlined design to improve use inside the oral cavity; it also has an ergonomic handle. HD-quality images ensure perfect rendering and maximum investigation accuracy. The optical system has a depth of field of 5 - 70 mm. The 16:9 HD sensor adapts perfectly to the LED monitor aspect ratio. The freeze-frame function is activated via the touch-sensitive key. The easy-to-attach and remove Macro Cap accessory magnifies up to 100x to deliver detailed, extremely sharp images.



## X-RAY SENSOR

The integrated Zen-X sensor, available in two sizes, is housed in the dentist's module, thus speeding up acquisition of intraoral X-ray images. In just a few seconds the reprocessed image is displayed on both monitor and control panel.



## 22" LED MONITOR

The 16:9 monitor ensures a perfect view of the images thanks to its ergonomic design and the special IPS panel that provides a wide viewing angle. The monitor can be integrated into the dental unit either with a single arm or a double-jointed arm for more comfortable use.

# A CONNECTED SURGERY

Simply by connecting to the internet with any browser, and without having to download any software, dentists and/or practice owners can access a website that offers a comprehensive range of digital services, remote assistance, video tutorials and updated user manuals for purchased models.



## DASHBOARD

A simple dashboard lets the dentist monitor dental unit activity across all functions and analyse dental practice efficiency. In larger surgeries this is an excellent tool for managing heavy workloads and planning maintenance tasks.

Where the patient sensor is present, statistical data on how the dental is used can be collected and processed; the information is transmitted to Di.V.A. and displayed on the dashboard.

## MONITORING HYGIENE SYSTEMS

Di.V.A. logs completed disinfection cycles, building up a database that is useful for in-practice assessment. This data also helps users estimate their consumption of disinfectant products and monitor the effective reactivation of equipment.

## INSTRUMENT MODE

The dashboard can also be used to monitor the effective usage of the integrated instruments.

## VIRTUAL ASSISTANT AND REMOTE MONITORING

Di.V.A. (Digital Virtual Assistant) optimises the workflow in advanced dental practices. In addition to being viewable on a PC, Di.V.A. can be easily consulted on smartphones and tablets.

In combination with Di.V.A., users can increase the efficiency of the practice by activating the EasyCheck service: each connected dental unit can rely on real-time remote diagnosis and technical support, vital for minimizing downtimes and ensuring continuity of service.

**easycheck**



# TECHNICAL SPECIFICATIONS

Puma ELI R

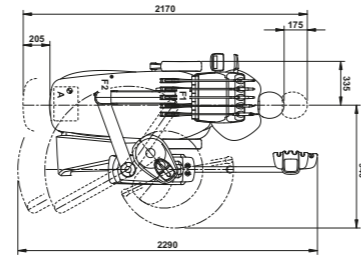
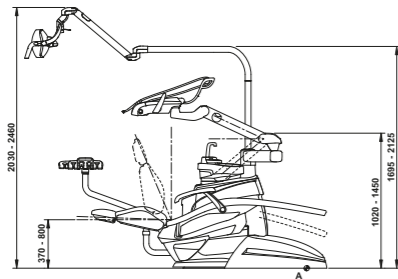

Puma ELI R CP

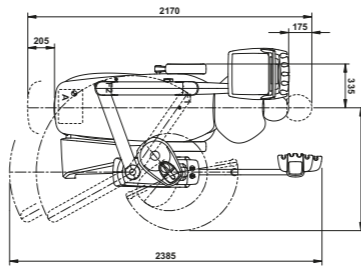
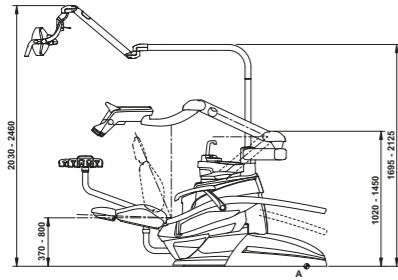

Puma ELI R ORTHO

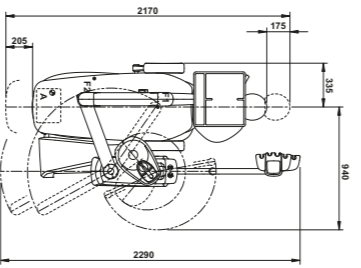
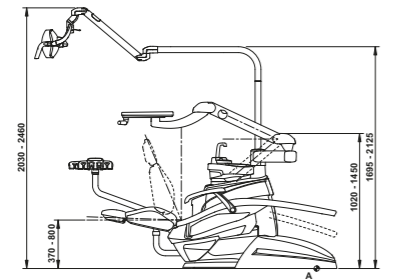

Puma ELI R CART

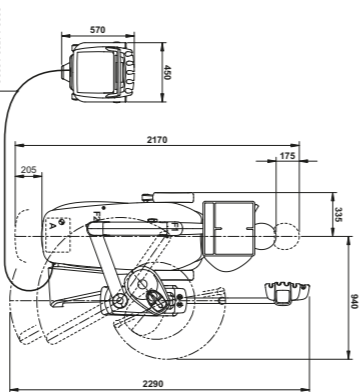
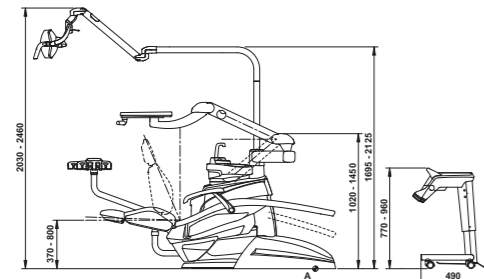

The measurements shown in the drawings are in mm.



- |                        |                            |
|------------------------|----------------------------|
| <b>COLOUR RANGE</b>    | <b>MEMORY FOAM PADDING</b> |
| 102 Atlantic blue      | 198 Atlantic blue          |
| 113 Pacific blue       | 183 Pacific blue           |
| 106 Mediterranean blue | 196 Mediterranean blue     |
| 136 Indian blue        | 186 Indian blue            |
| 101 Caribbean green    | 197 Caribbean green        |
| 123 Polynesian green   | 193 Polynesian green       |
| 103 Nevada yellow      | 182 Nevada yellow          |
| 115 Scottish salmon    | 195 Scottish salmon        |
| 132 Blueberry violet   | 192 Blueberry violet       |
| 134 Japanese wisteria  | 184 Japanese wisteria      |
| 135 Venetian red       | 194 Venetian red           |
| 130 Graphite black     | 180 Graphite black         |
| 121 Anthracite grey    | 199 Anthracite grey        |
| 137 Satin silver       | 187 Satin silver           |



	Puma ELI R	Over the patient delivery system	Hanging tubes	ORTHO	CART
<b>HYGIENE SYSTEM</b>					
Separate Supply System		○	○	○	○
Autosteril A (Automatic) for disinfection of the water circuit		○	○	-	○
Multi Water Bio controller - MWB. (EN 1717-compliant water infeed unit with continuous disinfection system)		○	○	○	○
Timed Flushing (quick water circuit flush cycle)		○	○	○	○
Suction Hose Disinfection (suction system wash and disinfection)		○	○	○	○
<b>DENTIST'S MODULE</b>					
Turbine KIT complete with Silent Power Evo 2 handpiece		●	●	-	●
Complete turbine kit with Silent Power Evo 4L fibre optics, quick coupling handpiece		○	○	-	○
Complete turbine kit with Silent Power Evo Miniature fibre optics, quick coupling handpiece		○	○	-	○
Handy Power induction Micromotor Kit (100 - 40,000 RPM - 3.3 Ncm)		●	●	-	●
Handy Power LED fibre optics induction Micromotor Kit (100 - 40,000 RPM - 3.3 Ncm)		○	○	-	○
Handy Power LED FLUO induction micromotor kit		○	○	○	○
Implantor LED induction Micromotor fibre optics kit (100 - 40,000 rpm - 5.3 Ncm)		○	○	-	○
Implantor LED FLUO induction micromotor kit		○	○	○	○
Piezosteril 6 scaler kit complete with 4 tips		○	○	-	○
Piezolight 6 scaler kit with fibre optics with 4 tips		○	○	-	○
T-LED curing light kit		○	○	-	○
Instrument lever stop kit		○	-	-	-
3-way stainless steel syringe kit		●	●	-	●
6-way stainless steel syringe kit		○	○	-	○
6th instrument kit (curing light or camera handpiece)		○	○	-	○
Integrated X-ray sensor		○	○	-	-
<b>ASSISTANT'S MODULE</b>					
T-LED curing light kit		○	○	○	○
3-way stainless steel syringe kit		○	○	○	○
6-way stainless steel syringe kit		○	○	○	○
Assistant's module with 4 holders and capacitive keypad, mounted on single arm		●	●	●	●
Assistant's module with 4 holders and capacitive keypad, mounted on double arm		○	○	○	○
Assistant's module with 5 holders and capacitive keypad, mounted on single arm		○	○	○	○
Assistant's module with 5 holders and capacitive keypad, mounted on double arm		○	○	○	○
Tray holder table on assistant's module		○	○	○	○
<b>OPERATING LAMP</b>					
Venus E LED lamp		●	●	●	●
Venus Plus lamp		○	○	○	○
Venus LED lamp		○	○	○	○
Venus LED MCT lamp		○	○	○	○
<b>UNIT BODY</b>					
Removable and position-adjustable cuspidor bowl		●	●	●	●
Cup filling sensor		○	○	○	○
Water-to-cup heater		○	○	○	○
Instrument spray heater		○	○	○	○
Independent cannulae selection		○	○	○	○
Quick coupling for air/water supply for external device		○	○	○	○
Multimedia cables and PC connections		○	○	○	○
Tray holder table in place of bowl		○	○	○	○
<b>PATIENT CHAIR</b>					
Patient presence sensor		○	○	○	○
Pneumatic headrest with 3-axis movement		○	○	○	○
Double-jointed headrest with 2-axis movement		●	●	●	●
Lateral slide foot control complete with joystick		●	●	●	●
Lateral slide foot control complete with joystick - wireless		○	○	○	○
Pressure-operated foot control with Joystick and spray on/off kit		○	○	○	○
Pressure-operated foot control with Joystick and spray on/off kit - wireless		○	○	○	○
Foot control, Power Pedal type		○	○	○	○
Foot control, Power Pedal type - wireless		○	○	○	○
Left armrest		○	○	○	○
Right armrest		○	○	○	○

● = supplied as standard ● = optional - = not available